

Article number: 20194B30B302BL

Description: E+G
T-angel clamps GN194-B30-B30-2-BL

Measures

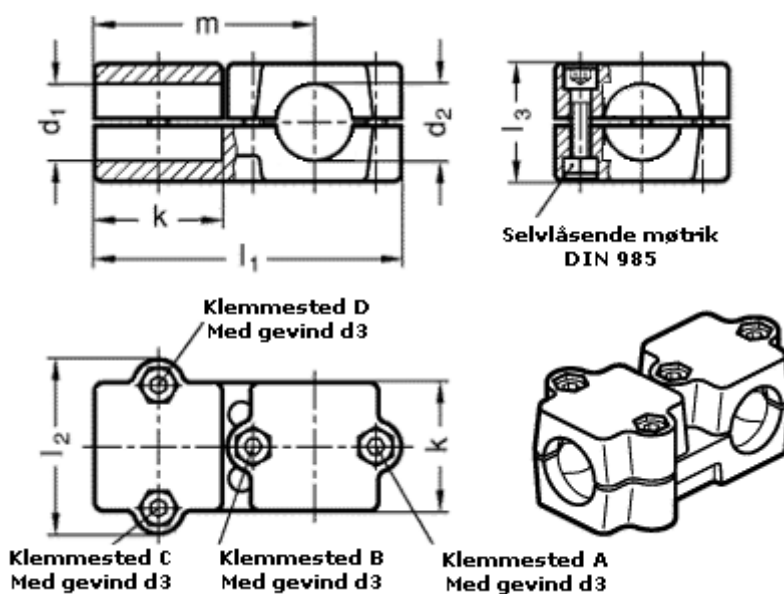

d1 = 30
d2 = 30
d3 = M 8
k = 50
l1 = 120
l2 = 68
l3 = 46
m = 85